

Please use the line art shown below to confirm the information you stated on the front of this order form. Illustrations shown below are the body styles only (braid is not illustrated because multiple options are available for each style). You will need to indicate the body color(s) and draw in the braid style of choice, with color placement(s) for added clarification.

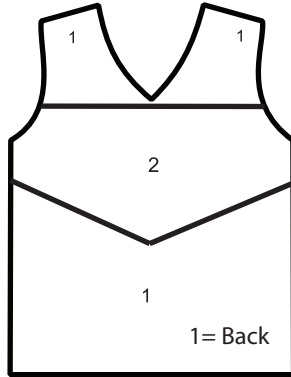

Custom-Stock C100(Y) & Custom-Stock C105(Y)



Custom-Stock C106(Y)

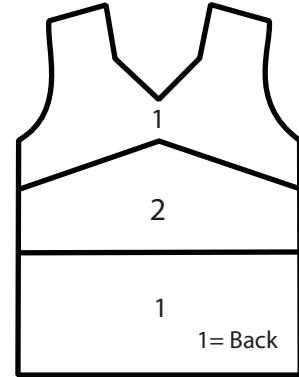

Custom-Stock C102P(Y)*

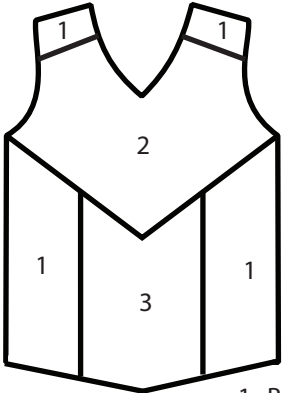

Custom QC109(Y)



Custom QC108(Y)

*When 1" two color-two stripe braid is chosen at the legs, the colored stripe will always face in and the white stripe will always face out.

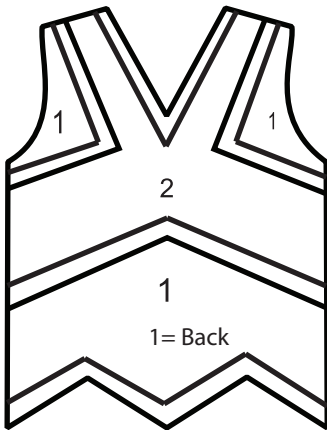

Custom QC104(Y) & Custom-Stock C104L(Y)

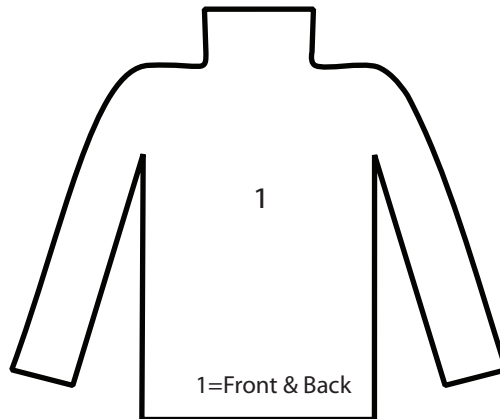

Custom QC103(Y)

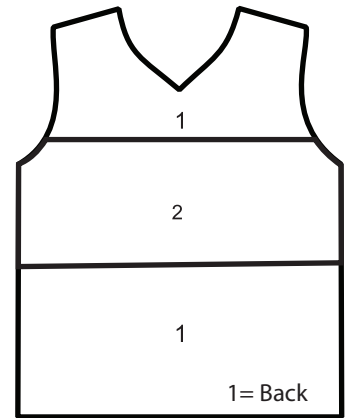

Custom QC107(Y)

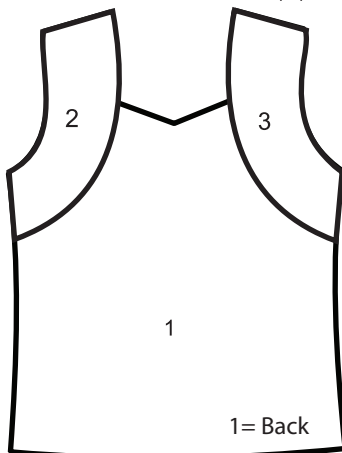

Custom QC117 (Y)

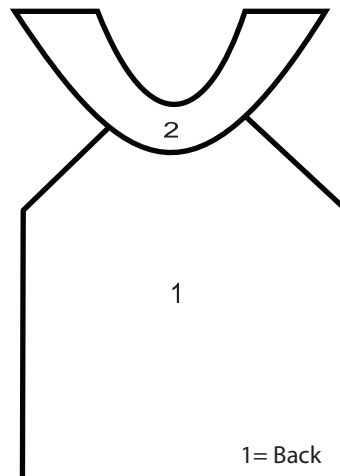

Custom QC113 (Y)

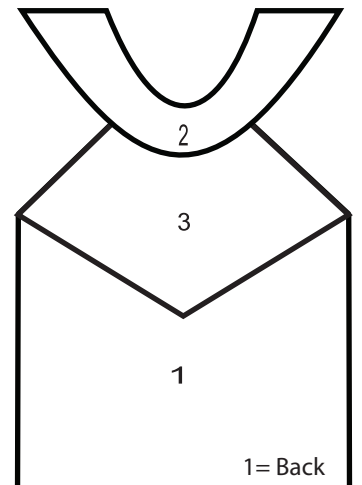

Custom QC114 (Y)

Please use the line art shown below to confirm the information you stated on the front of this order form. Illustrations shown below are the body styles only (braid is not illustrated because multiple options are available for each style). You will need to indicate the body color(s) and draw in the braid style of choice, with color placement(s) for added clarification.

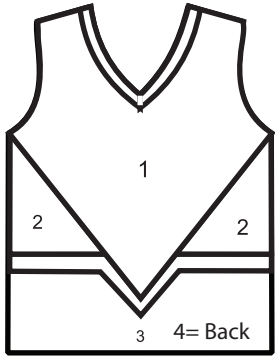

Custom QC119 (Y)

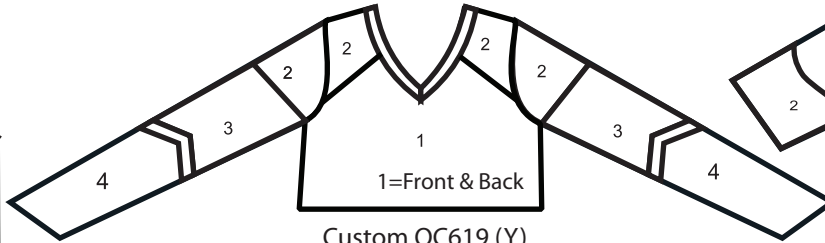

Custom QC619 (Y)

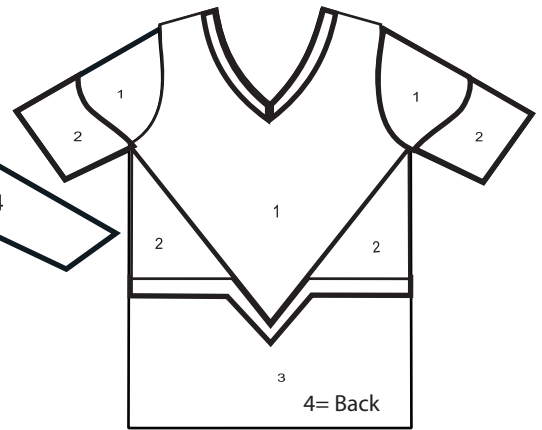

Custom QC121 (Y)

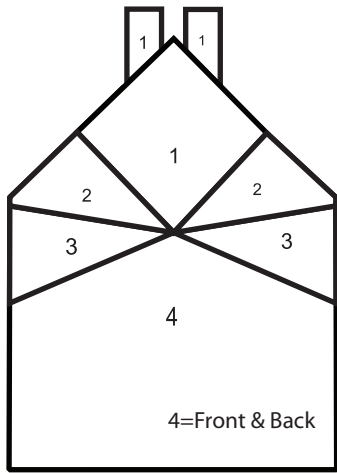

Custom QC122(Y)

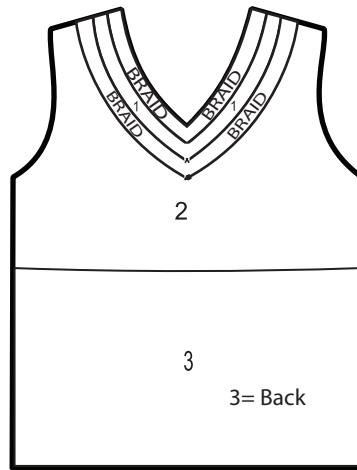

Custom QC115 (Y)

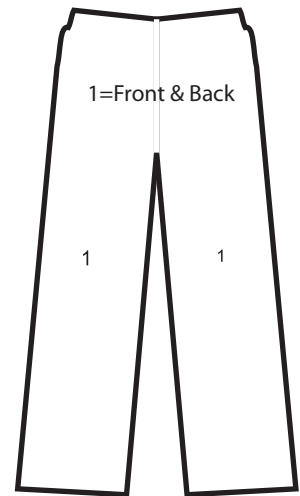

Custom QC502 (Y)

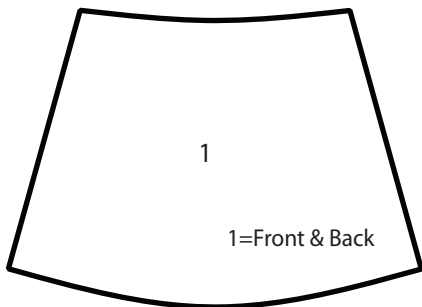

Custom-Stock & Stock Skirts
Excluding C201M/Y & C210M/Y

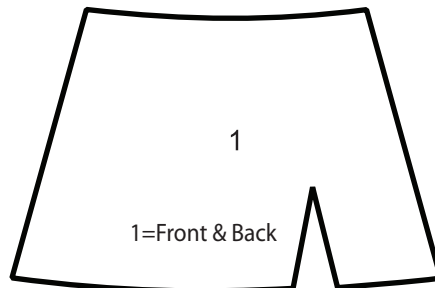

Custom QC207 (Y)

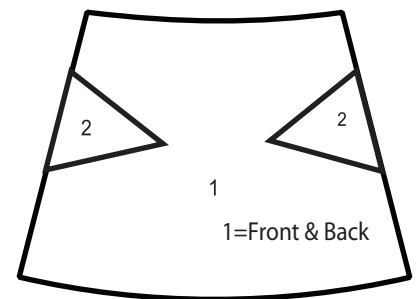

Custom QC206 (Y)

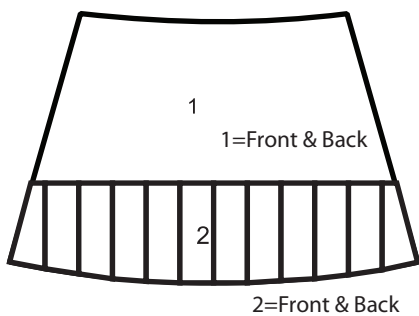

Custom QC209 (Y)

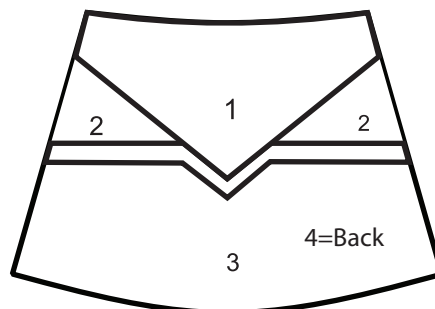

Custom QC219(Y)

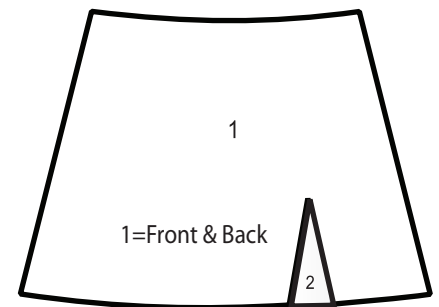

Custom QC208 (Y)



Alleson Cheerleading Custom & Custom-Stock Uniform SHELL Order Form

Date: _____ Account Number: _____

PO # Number: _____ Shipping Instructions: _____

Sold To: _____

Street: _____

City: _____ State: _____ Zip: _____

Ship To: _____

Street: _____

City: _____ State: _____ Zip: _____

Refer to the catalog for specific color placement descriptions by style.

SHELL STYLE	Color 1	Color 2	Color 3	Color 4	2XS	XS	S	M	L	XL	2XL	3XL	Cost Per Piece	Total QTY	TOTAL COST
Example: Page 22 QC122	WH	NA	WH	NA				1	1				\$44.00	2	\$88.00
Example: Page 22 QC122	WH	NA	WH	NA								1	\$50.00	1	\$50.00
Total															

BRAID STYLE*	Color 1	Color 2	Color 3	Color 4	Color 5	Add't Charges (per piece)	Total QTY	Total Cost
Example: Page 22 (Renton Uniform) QCRP5TV (Top V Front Braiding)	WH	NA	WH			List: \$5.00	3	\$15.00
QCRP5LV (Lower Inverted V Front Braiding)	WH	NA	WH			List: \$5.00	3	\$15.00
QCRP5S (Strap Braiding)	WH	NA	WH			List: \$5.00	3	\$15.00
Total Additional Charges								

*OVERLAY/INSERT OPTIONS	Color 1	Color 2	Add't Charges (per piece)	Total QTY	Total Cost
Example: Page 22 (Renton Uniform) QCRPFT (Top chest panel and straps FOIL insert)	SM		List: \$10.00	3	\$30.00
QCRPFL (Lower triangle panel FOIL insert)	SM		List: \$8.00	3	\$24.00
Total Additional Charges					

*Custom & Custom-Stock garments have specific braid, overlay/insert location codes. Refer to the How To Order Pages in the catalog to ensure you are noting the proper codes for each individual garment.

Embroidery and/or twill included with uniform order (fax the information over with this form)



Alleson Cheerleading
Custom & Custom-Stock Uniform
SKIRT Order Form

Date: _____ Account Number: _____

PO # Number: _____ Shipping Instructions: _____

Sold To: _____

Street: _____

City: _____ State: _____ Zip: _____

Ship To: _____

Street: _____

City: _____ State: _____ Zip: _____

Refer to the catalog for specific color placement descriptions by style.

SKIRT STYLE	Color 1	Color 2	Color 3	Color 4	2XS	XS	S	M	L	XL	2XL	3XL	4XL	5XL	Cost Per Piece	Total QTY	TOTAL COST
Example: Page 22 QC219	NA	WH	NA	NA				1		1					\$42.00	2	\$84.00
Total																	

BRAID STYLE*	Color 1	Color 2	Color 3	Color 4	Color 5	Add't Charges (Per Piece)	Total QTY	Total Cost
Example: Page 22 (Renton Uniform) QCIS5C	WH	NA	WH			List: N/C		
Total Additional Charges								

*OVERLAY/INSERT OPTIONS	Color 1	Color 2	Add't Charges (Per Piece)	Total QTY	Total Cost
Example: Page 22 QCISFS (Side Panel Foil Insert)	SM		List: \$6.00	2	\$12.00
Total Additional Charges					

*Custom & Custom-Stock garments have specific braid, overlay/insert options and also location codes. Refer to the How To Order Pages in the catalog to ensure you are noting the proper codes for each individual garment.